

TUBELIGHT FUN



TUBELIGHT FUN, un luminaire étanche et résistant aux chocs.

L'éclairage qui génère des émotions et favorise l'expérience client. Que ce soit la lumière d'un hall d'accueil, d'un bureau, d'un concept store, d'un jardin ou bien d'un corner, faites sensation ! L'éclairage RVB, créé à partir des 3 couleurs primaires (rouge, vert et bleu), permet d'obtenir un large panel de couleurs et d'être utilisé de manière fixe ou variable afin de personnaliser au maximum votre éclairage d'ambiance. La gamme FUN transforme et théâtralise un lieu.



www.tubelightfrance.com

Showroom Paris
20 rue Robert Fleury,
75015 PARIS

Showroom Rodez
110 rue du Dr Théodor Mathieu,
12000 RODEZ

Usine/fabrication
Parc du tumulus,
12130 PIERREFICHE D'OLT



RÉFÉRENCES PRODUITS

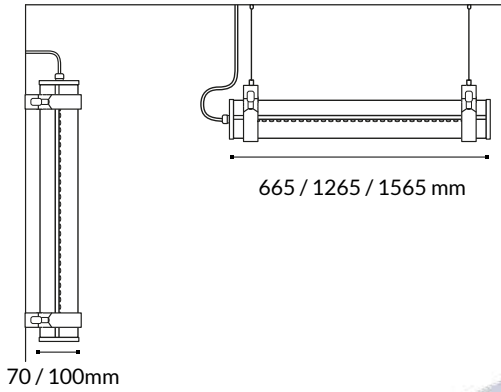

Système dimmable
pilotable avec la
télécommande



TUBELIGHT FUN

		Ø 70			Ø 100		
ø x L (mm)		70 x 665	70 x 1265	70 x 1565	100 x 665	100 x 1265	100 x 1565
CLAIR	Rouge	TFSR6CBM	TFSR12CBM	TFSR15CBM	TFR6CBM	TFR12CBM	TFR15CBM
	Vert	TFSV6CBM	TFSV12CBM	TFSV15CBM	TFV6CBM	TFV12CBM	TFV15CBM
	Bleu	TFSB6CBM	TFSB12CBM	TFSB15CBM	TFB6CBM	TFB12CBM	TFB15CBM
	RVB	TFSRVB6CBM	TFSRVB12CBM	TFSRVB15CBM	TFRVB6CBM	TFRVB12CBM	TFRVB15CBM
OPALE	Rouge	TFSR6OBM	TFSR12OBM	TFSR15OBM	TFR6OBM	TFR12OBM	TFR15OBM
	Vert	TFSV6OBM	TFSV12OBM	TFSV15OBM	TFV6OBM	TFV12OBM	TFV15OBM
	Bleu	TFSB6OBM	TFSB12OBM	TFSB15OBM	TFB6OBM	TFB12OBM	TFB15OBM
	RVB	TFSRVB6OBM	TFSRVB12OBM	TFSRVB15OBM	TFRVB6OBM	TFRVB12OBM	TFRVB15OBM



INFORMATIONS TECHNIQUES



Câblé avec détecteur de mouvement
TUBF9



Kit de jumelage TUBE-Light en Ø70 **LEDKJS2T** et Ø100 **LEDKJ2T**



Kit de suspension réglage automatique
LEDSUPTUBSA



Kit de suspension
LEDSUPTUBS

Embouts en INOX 316L et presse-étoupe laiton chromé



Goupille antivandale Ø70 (en option pour Ø100)
TUBF8



Interrupteur ON/OFF sur embout de finition
TUBF11

2 brides de fixations en INOX 316L

Assemblage bi-matières (méthacrylate/polycarbonate) permettant résistance mécanique et chimique.



Dérivateur en T étanche démontable 3 plots connecteur automatique
LEDDERIV3PA



Prolongateur étanche démontable 3 plots
LEDPLG3P



Prolongateur étanche démontable 3 plots connecteur automatique
LEDPLG3PA

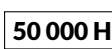



OPTIONS CÂBLAGE

Câblage standard



Câblage traversant (2 côtés)

TUBF1

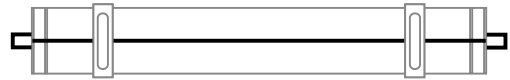

Câblé avec connecteur débrochable (1 côté)

TUBF4



Câblé en HO5RRF 0,4 m (1 côté)

Disponible en 1m/ 2m/3m/5m

TUBF2



Câblé (1 côté) en HO5RRF 0,4 m avec connecteur débrochable

TUBF6



Câblé en HO5RRF 0,4 m (2 côtés)

Disponible en 1m/ 2m/3m/5m

TUBF3

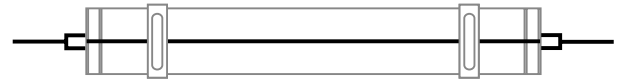

Câblé (2 côtés) en HO5RRF 0,4 m avec connecteur débrochable

TUBF7

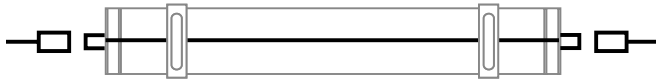

Câblé (2 côtés) avec connecteur débrochable

TUBF5

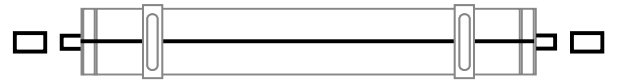



PERSONNALISER SON TUBELIGHT

1 | Option personnalisation du câble d'alimentation Tubelight



T2701



T2702



T2703



T2704



T2705



T2706



T2707



T2708



T2709



T2710



Câble protégé
par gaine inox
tressé 316L
T2711



T2712



Câblage
débrochable
T2713

2 | Choisir la couleur des embouts et brides suivant le RAL souhaité

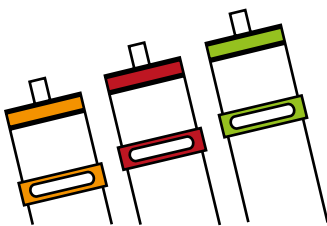

Option finition couleur standard (RAL) - 2 embouts + 2 brides - pour Ø70 **TUBSC** - pour Ø100 **TUBC** -

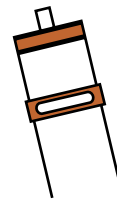

Option finition Corten (effet rouille) - 2 embouts + 2 brides - pour Ø70 **TUBSR** - pour Ø100 **TUBR** -

3 | Personnalisation d'embout⁽²⁾ avec votre logo

4 | Réalisation de longueurs spécifiques ⁽²⁾ De 1,50 m à 6 m maximum.

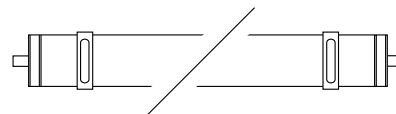

(2) Minimum de commande 20 Tubelight



CONTACTEZ NOTRE SERVICE COMMERCIAL POUR
UNE ÉTUDE PERSONNALISÉE : 05 65 68 00 22

www.tubelightfrance.com



Showroom Paris
20 rue Robert Fleury,
75015 PARIS

Showroom Rodez
110 rue du Dr Théodor Mathieu,
12000 RODEZ

Usine/fabrication
Parc du tumulus,
12130 PIERREFICHE D'OLT